

# IN\_LINE TUB M A 140

Code	06.0514.19.930.BK
Color	Black
Input Wattage	19 W
Luminaire luminous flux	1640 Lm
Luminaire efficacy	86.3 lm/W
CCT	3000K
CRI	>90
Voltage (V)	48V
Warranty	5 Years
IP Grade	IP20

## OPTICAL

Type	CREE LED
Light beam angle	50°
Light distribution	Symmetric

## ELECTRICAL

Driver	Included
Power factor	0.8
LED input Voltage (nominal)	36V
LED input Current (nominal)	500mA
Dimming	NO DIM
Electrical insulation class	Class III

## OTHER DATA

Track type	IN_LINE TRACK 48V DC
Swivel angle	90°
Rotation angle	355°
Materials	Aluminium / Polycarbonate
Weight	0.2 kg
Gross weight	0.36 kg



## DIMENSIONS

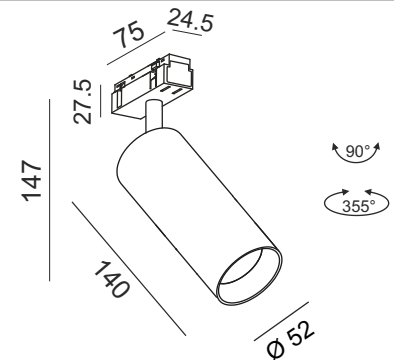

## ACCESSORY

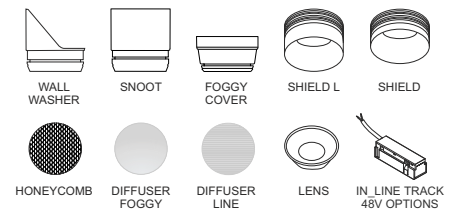

## CERTIFICATIONS



# TUB M ACCESSORY

Model WALL WASHER TUB M  
Category Accessories

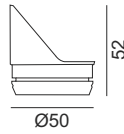

Code 06.A05WW  
Color Black

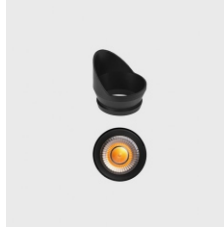

# TUB M ACCESSORY

Model SNOOT TUB M  
Category Accessories

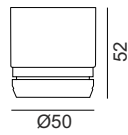

Code 06.A05NB  
Color Black

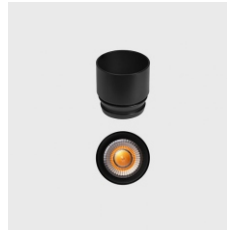

# TUB M ACCESSORY

Model FOGGY COVER TUB M  
Category Accessories

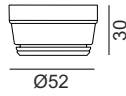

Code 06.A05FG  
Color Mat white

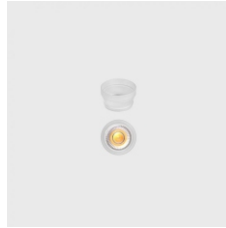

# TUB M ACCESSORY

Model SHIELD L TUB M  
 Category Accessories

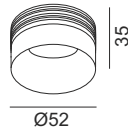

Code 06.A05SHL.BR  
 Color Brass



Code 06.A05SHL.CP  
 Color Copper

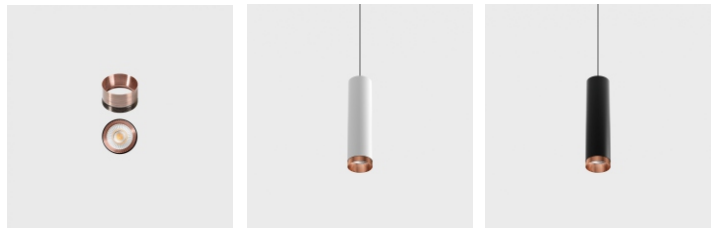

# TUB M ACCESSORY

Model SHIELD TUB M  
 Category Accessories

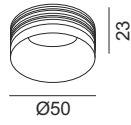

Code 06.A05SH.BR  
 Color Brass



Code 06.A05SH.CP  
 Color Copper

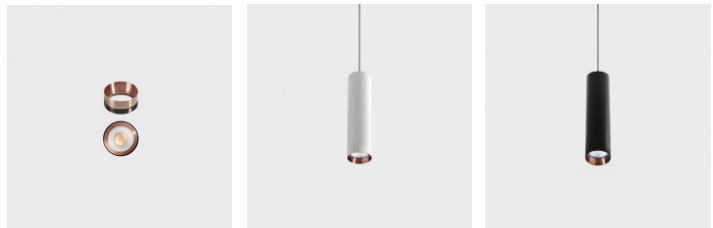

# TUB M ACCESSORY

Model HONEYCOMB TUB M  
Category Accessories

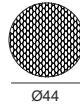

Code 06.A05HC  
Color Black

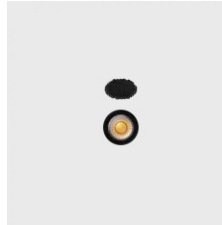

# TUB M ACCESSORY

Model DIFFUSER FOGGY TUB M  
Category Accessories



Code 06.A05SFT  
Color Foggy

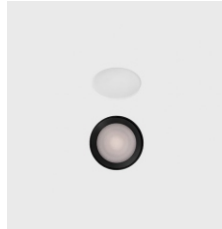



# TUB M ACCESSORY

Model DIFFUSER LINE TUB M  
Category Accessories



Code 06.A05ELPS  
Color Transparent

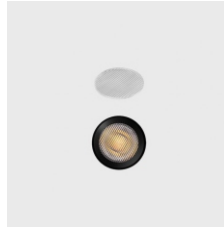

# TUB M ACCESSORY

Model LENS TUB M  
Category Accessories



Code 06.A05LS15  
Light beam angle 15°  
Color Transparent



Code 06.A05LS30  
Light beam angle 30°  
Color Transparent



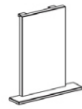
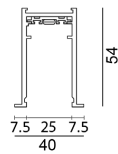

## IN\_LINE TRACK T

	Code	Dimensions (mm): LxWxH	Color
IN_LINE TRACK T 48V 2m*	<b>06.T200.BK</b>	2000 x 40 x 54	Black
IN_LINE TRACK T 48V 3m*	<b>06.T300.BK</b>	3000 x 40 x 54	Black
IN_LINE CORNER T HR*	<b>06.T90HR.BK</b>	85 x 85 x 54	Black
IN_LINE END CAP T*	<b>06.TECAP.BK</b>	40 x 7.5 x 54	Black
Mounting bracket*	<b>06.TCB.BK</b>		Black
IN_LINE TRACK T MEC JOINT*	<b>06.TLNCON</b>		Black

\*Electrical connection not included

IN\_LINE CORNER R HR

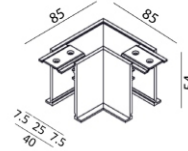

MOUNTING BRACKET



IN\_LINE TRACK T MEC JOINT\*

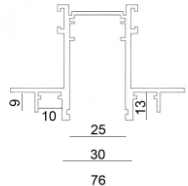
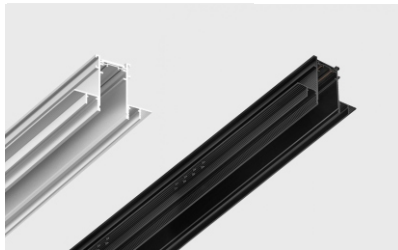

## IN\_LINE TRACK R

	Code	Dimensions (mm): LxWxH	Color
IN_LINE TRACK T 48V 2m*	<b>06.R200.WH</b>	2000 x 30 x 54	White
IN_LINE TRACK T 48V 2m*	<b>06.R200.BK</b>		Black
IN_LINE TRACK T 48V 3m*	<b>06.R300.WH</b>	3000 x 30 x 54	White
IN_LINE TRACK T 48V 3m*	<b>06.R300.BK</b>		Black
IN_LINE CORNER R HR *	<b>06.R90HR.WH</b>	82 x 82 x 54	White
IN_LINE CORNER R HR *	<b>06.R90HR.BK</b>		Black
IN_LINE CORNER R IN *	<b>06.R90IN.WH</b>	82 x 82 x 54	White
IN_LINE CORNER R IN *	<b>06.R90IN.BK</b>		Black
IN_LINE CORNER R OUT *	<b>06.R90OUT.WH</b>	82 x 82 x 54	White
IN_LINE CORNER R OUT *	<b>06.R90OUT.BK</b>		Black
IN_LINE END CAP R/S *	<b>06.R/SECAP.WH</b>	30 x 4 x 54	White
IN_LINE END CAP R/S *	<b>06.R/SECAP.BK</b>		Black

\*Electrical connection not included

IN\_LINE CORNER R HR

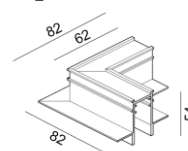

IN\_LINE CORNER R IN

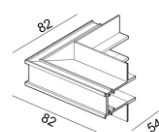

IN\_LINE CORNER R OUT

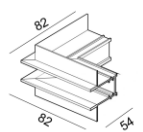

## CERTIFICATIONS



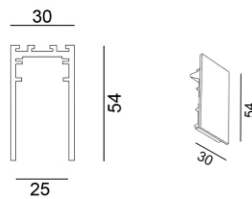
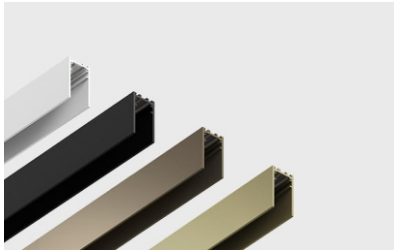

## IN\_LINE TRACK S

	Code	Dimensions (mm): LxWxH	Color
IN_LINE TRACK S 48V 2m*	06.S200.WH	2000 x 30 x 54	White
IN_LINE TRACK S 48V 2m*	06.S200.BK		Black
IN_LINE TRACK S 48V 2m*	06.S200.LG		Like gold
IN_LINE TRACK S 48V 2m*	06.S200.LB		Like brass
IN_LINE TRACK S 48V 3m*	06.S300.WH	3000 x 30 x 54	White
IN_LINE TRACK S 48V 3m*	06.S300.BK		Black
IN_LINE CORNER S HR *	06.S90HR.WH	58 x 58 x 54	White
IN_LINE CORNER S HR *	06.S90HR.BK		Black
IN_LINE CORNER S HR *	06.S90HR.LG		Like gold
IN_LINE CORNER S HR *	06.S90HR.LB		Like brass
IN_LINE CORNER S IN *	06.S90IN.WH	82 x 82 x 54	White
IN_LINE CORNER S IN *	06.S90IN.BK		Black
IN_LINE CORNER S OUT *	06.S90OUT.WH	82 x 82 x 54	White
IN_LINE CORNER S OUT *	06.S90OUT.BK		Black
IN_LINE CORNER 90	06.SE90HR.WH	70 x 70 x 54	White
IN_LINE CORNER 90	06.SE90HR.BK		Black
IN_LINE CORNER 180	06.SE180HR.WH	110 x 30 x 54	White
IN_LINE CORNER 180	06.SE180HR.BK		Black
IN_LINE CORNER X	06.SEQHR.WH	110 x 110 x 54	White
IN_LINE CORNER X	06.SEQHR.BK		Black
IN_LINE CORNER 120	06.SE120HR.WH	116 x 60 x 54	White
IN_LINE CORNER 120	06.SE120HR.BK		Black
IN_LINE CORNER T (right)	06.SETRHR.WH	110 x 70 x 54	White
IN_LINE CORNER T (right)	06.SETRHR.BK		Black
IN_LINE CORNER T (left)	06.SETLHR.WH	110 x 70 x 54	White
IN_LINE CORNER T (left)	06.SETLHR.BK		Black
IN_LINE END CAP R/S *	06.R/SECAP.WH	30 x 4 x 54	White
IN_LINE END CAP R/S *	06.R/SECAP.BK		Black
IN_LINE END CAP R/S *	06.R/SECAP.LG		Like gold
IN_LINE END CAP R/S *	06.R/SECAP.LB		Like brass

\*Electrical connection not included

IN\_LINE CORNER R HR

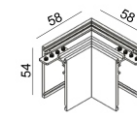

IN\_LINE CORNER R IN

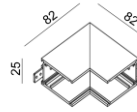

IN\_LINE CORNER R OUT

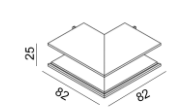

IN\_LINE CORNER 90

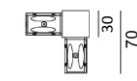

IN\_LINE CORNER 180

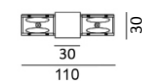

IN\_LINE CORNER X

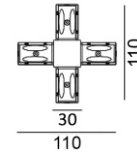

IN\_LINE CORNER 120

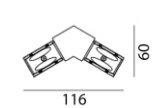

IN\_LINE CORNER T (left)

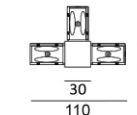

IN\_LINE CORNER T (right)

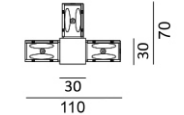

## CERTIFICATIONS



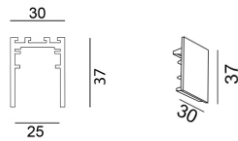
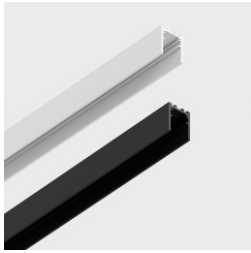

## IN\_LINE SHORT TRACK S

	Code	Dimensions (mm): LxWxH	Color
IN_LINE SHORT TRACK S 48V 3m with caps (2pcs)*	<b>06.SS300.WH</b>	3000 x 30 x 37	White
IN_LINE SHORT TRACK S 48V 3m with caps (2pcs)*	<b>06.SS300.BK</b>		Black
IN_LINE SHORT CORNER S HR*	<b>06.SS90HR.WH</b>	58 x 58 x 27	White
IN_LINE SHORT CORNER S HR*	<b>06.SS90HR.BK</b>		Black
IN_LINE SHORT END CAP*	<b>06.SSCAP.WH</b>	30 x 3 x 37	White
IN_LINE SHORT END CAP*	<b>06.SSCAP.BK</b>		Black

## IN\_LINE SHORT CORNER S HR

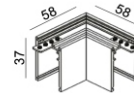

\*Electrical connection not included

## ALL 48V TRACK IN\_LINE

### IN\_LINE LIVE END 600

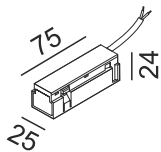

	Code	Dimensions (mm): LxWxH	Color
Feed cable	<b>06.SLE60.WH</b>	600	White
	<b>06.SLE60.BK</b>	600	Black

### IN\_LINE LIVE END 1500

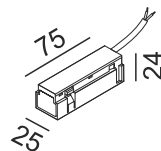

	Code	Dimensions (mm): LxWxH	Color
Feed cable	<b>06.SLE150.WH</b>	1500	White
	<b>06.SLE150.BK</b>	1500	Black

### IN\_LINE ELECTRICAL JOINT

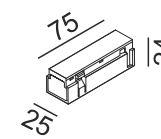

	Code	Color
Electrical joint live end for track, without cable	<b>06.SLE00.WH</b>	White
	<b>06.SLE00.BK</b>	Black

### IN\_LINE ELECTRICAL JOINT FLEX

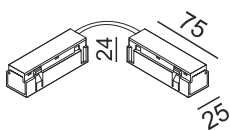

	Code	Color
Electrical joint flex connector for tack	<b>06.S2LE60.WH</b>	White
	<b>06.S2LE60.BK</b>	Black

## CERTIFICATIONS



## ALL 48V TRACK IN\_LINE

## IN\_LINE MEC JOINT

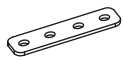

	Code	Color
Mechanical linear connector for track	06.R/SLNCON	Black

## IN\_LINE COVER R/S

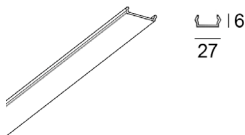

	Code	Dimensions (mm): LxWxH	Color
Track cover for Recessed & Surface	06.R/SCOV200.WH	2000 x 26 x 5	White
	06.R/SCOV200.BK		Black
	06.R/SCOV300.WH	3000 x 26 x 5	White
	06.R/SCOV300.BK		Black

## IN\_LINE SUSP KIT



	Code	Dimensions (mm): LxWxH	Color
Suspension	06.SS150.WH	1500 x 26 x 5	White
	06.SS150.BK		Black
	06.SS150.ZZ		Steel

## CERTIFICATIONS



## ALL 48V TRACK IN\_LINE

## IN\_LINE POWER UNIT 100

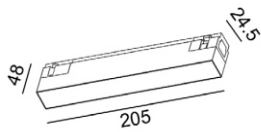

	Code	Power Watt	Color
Power supply	06.PSU.100.WH	100	White
	06.PSU.100.BK	100	Black

CE ENE IP20 SELV 48V

## IN\_LINE POWER UNIT 200

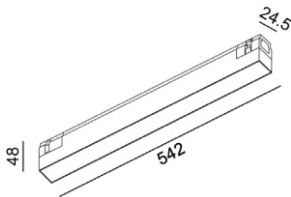

	Code	Power Watt	Color
Power supply	06.PSU.200.WH	200	White
	06.PSU.200.BK	200	Black

CE ENE IP20 SELV 48V

## POWER SUPPLY



	Code	Dimensions (mm): LxWxH	Power Watt	Color
	PS-60-48	162,5 x 42,5 x 32	60	Grey
	PS-100-48	190 x 52 x 37	100	Grey
	PS-150-48	191 x 63 x 37,5	150	Grey

CE IP67 48V

## POWER SUPPLY



	Code	Dimensions (mm): LxWxH	Power Watt	Color
	06.PSU.100.W/O	298 x 30 x 16,5	100	Grey
	06.PSU.200.W/O	384 x 30 x 22	200	Grey
	06.PSU.250.W/O	384 x 30 x 22	250	Grey

CE IP20 48V

## CERTIFICATIONS

