

SOL IN MINI

Code	01.7526.7.930.BK
Color	Black
Input Wattage	7 W
Luminaire luminous flux	624 Lm
Luminaire efficacy	89,14 lm/W
CCT	3000K
CRI	>90
Voltage (V)	220-240V, 50/60Hz
Warranty	5 Years
IP Grade	IP20

OPTICAL

Type	CREE LED
Light beam angle	45°
Light distribution	Symmetric

ELECTRICAL

Driver	Included
Power system	8,2 W
Output Current	350mA
Output Voltage	13V-22V
Dimming	NO DIM
Input Voltage	220-240V
Input Frequency	50-60Hz
Dimension ØxH(mm)	Ø43 x 20
Protection type	IP20
Construction material	Plastic
Driver mounting	Remote
Ta °C	-20°C to 50°C
Tc °C	75°C

OTHER DATA

Cutout dimension (mm)	Ø68mm
Recommended height (mm)	42mm
Swivel angle	90°
Rotation angle	355°
Fixings Hardware	Metal clip
Mounting	Ceiling recessed trim
Construction material	Aluminium / Polycarbonate
Operating Ambient Temp.	-20 to 40 °C
Weight	0,2 kg
Gross weight	0,3 kg

CERTIFICATIONS

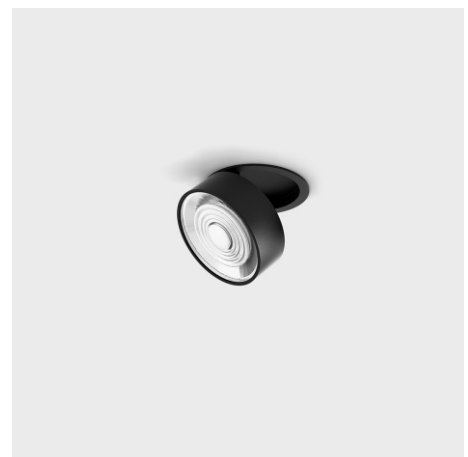

DIMENSIONS

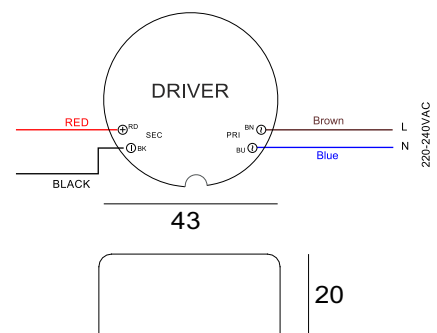
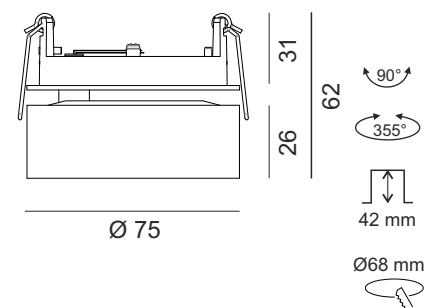

ACCESSORY

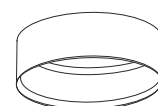

SOL M RING

SOL M ACCESSORY

Model SOL M GRAIN
 Category Accessories

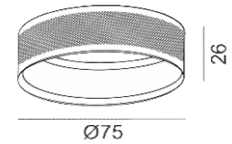

Code SOL M GRN WH
 Color WHITE



Code SOL M GRN BK
 Color BLACK



Code SOL M GRN BR
 Color BRASS

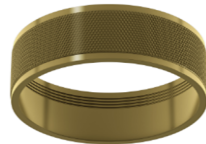

Code SOL M GRN CP
 Color COPPER



Code SOL M GRN CR
 Color CHROME

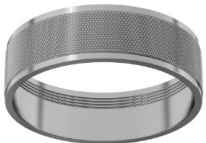

Code SOL M GRN CF
 Color COFFEE



Code SOL M GRN BZ
 Color BRONZE



Code SOL M GRN DB
 Color DIAMOND BLACK



Code SOL M GRN SB
 Color SAHARA BEIGE



CERTIFICATIONS

